

ICOM

INSTRUCTION MANUAL

VHF MARINE TRANSCEIVER
(General version)

IC-M9

Icom Inc.

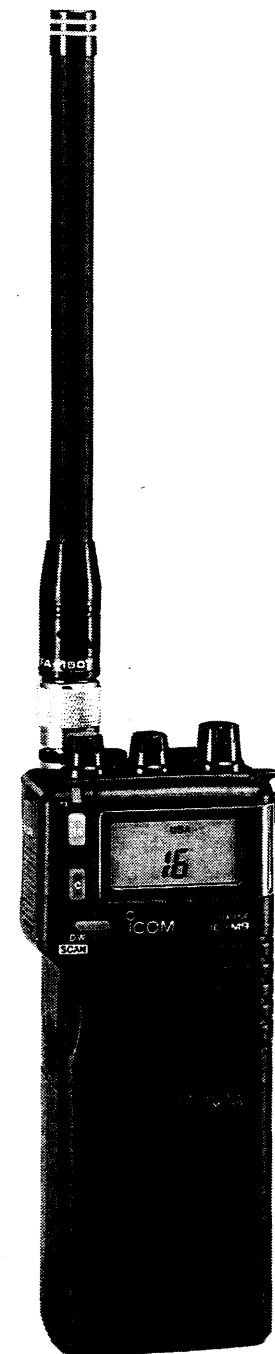

IMPORTANT

READ ALL INSTRUCTIONS carefully and completely before using the transceiver.

SAVE THIS INSTRUCTION MANUAL – This instruction manual contains important safety and operating instructions for the IC-M9.

UNPACKING

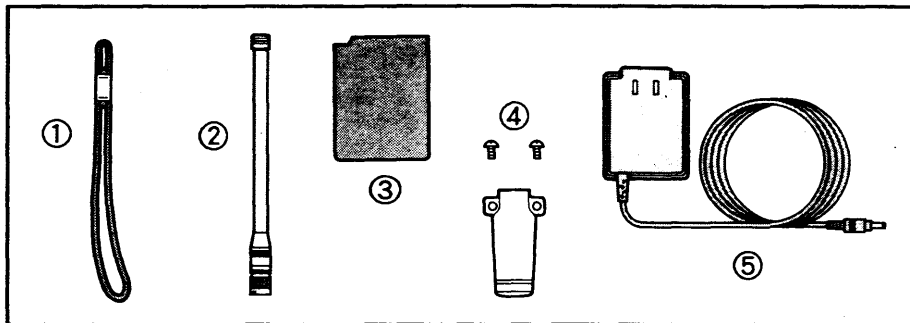

Accessories included with the IC-M9:	Qty.
① Handstrap.....	1
② Flexible antenna.....	1
③ Attached Ni-Cd battery pack.....	1
④ Belt clip and screws.....	1 set
⑤ Wall charger.....	1

CAUTIONS

NEVER connect the transceiver via the [CHARGE] jack to an AC outlet or to a power source of more than 18 V DC. These connections will ruin the transceiver.

KEEP the transceiver out of the reach of children.

AVOID exposing the transceiver to heavy rain/snow or excessive moisture.

NEVER charge battery packs except in the methods described in this manual.

The use of non-Icom battery packs/chargers may impair transceiver performance and invalidate the warranty.

AVOID using the transceiver in areas with temperatures below -20°C or above $+60^{\circ}\text{C}$. The transceiver may not operate correctly.

BE CAREFUL! The [CHARGE] jack on the transceiver cannot be used as an external power jack. Use only a battery pack as a power supply.

BE CAREFUL! If immersed in fresh or saltwater permanent damage may result.

TABLE OF CONTENTS

IMPORTANT	i	5 SET MODE.....	12
UNPACKING	i	■ Set mode programming	12
CAUTIONS	i	■ Set mode items	12
TABLE OF CONTENTS	ii		
1 PRE-OPERATION	1-4	6 SCAN FUNCTIONS	13-14
■ Operating rules	1	■ Scan types	13
■ Accessory attachment	2	■ Starting a scan	14
■ Charging notes	3	■ Channel lockout	14
■ Battery life	3		
■ Cautions	3	7 OPTIONAL VOICE SCRAMBLER UNIT	15-16
2 PANEL DESCRIPTION	5-7	■ Installation	15
■ Front and side panels	5	■ Activating the scrambler	16
■ Top panel	6	■ Programming codes	16
■ Function display	7		
3 BASIC OPERATION	8-10	8 TROUBLESHOOTING AND CHANNEL LIST	17-18
■ Channel selection	8	■ Troubleshooting	17
■ Receiving	9	■ Resetting the CPU	18
■ Dual watch/tri-watch	9	■ Channel list	18
■ Transmitting	10		
■ Lock function	10	9 SPECIFICATIONS AND OPTIONS	19-20
■ Function display backlighting	10	■ Specifications	19
		■ Options	19
4 MEMORY AND CALL CHANNEL PROGRAMMING	11		
■ Memory channels	11		
■ Call channel	11		

■ Operating rules

• PRIORITIES

- 1) Read all rules and regulations pertaining to priorities and keep an up-to-date copy handy. Safety and distress calls take priority over all others.
- 2) You must monitor channel 16 when you are not operating on another channel.
- 3) False or fraudulent distress calls are prohibited under law.

• PRIVACY

- 1) Information overheard but not intended for you cannot lawfully be used in any way.
- 2) Indecent or profane language is prohibited.

• RADIO LICENSES

(1) SHIP STATION LICENSE

When your craft is equipped with a VHF FM transceiver, you must have a current radio station license before using the transceiver. It is unlawful to operate a ship station which is not licensed.

Inquire through your dealer or the appropriate government agency for a Ship-Radiotelephone license. This license includes the call sign which is your craft's identification for radio purposes.

(2) OPERATOR'S LICENSE

A Restricted Radiotelephone Operator Permit is the license most often held by small vessel radio operators when a radio is not required for safety purposes. You can usually obtain this permit by mail.

The Restricted Radiotelephone Operator Permit must be posted near the transceiver or be kept with the operator. Only a licensed radio operator may operate a transceiver.

However, non-licensed individuals may talk over a transceiver if a licensed operator starts, supervises, ends the call and makes the necessary log entries.

A current copy of the applicable government rules and regulations is usually required to be on hand.

■ Accessory attachment

• FLEXIBLE ANTENNA

Insert the supplied antenna into the antenna connector and rotate the antenna as shown in the diagram.

KEEP the dust cover in place when jacks are not in use to avoid bad contacts.

CAUTION: Transmitting without an antenna may damage the transceiver.

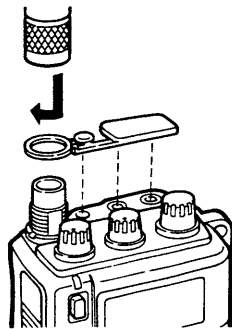

• BELT CLIP

Remove the plastic screws, then attach the belt clip using the supplied metal screws. Conveniently attaches to your belt.

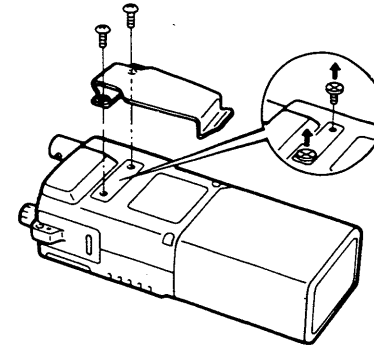

• HANDSTRAP

Attach the handstrap as shown in the diagram. Facilitates carrying.

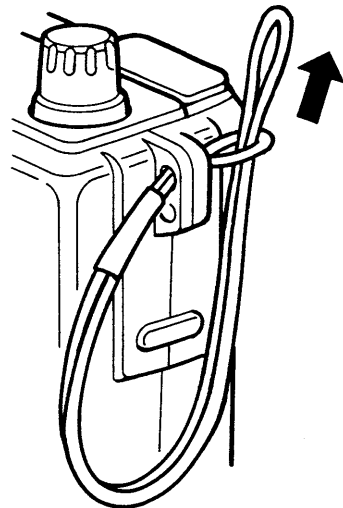

• BATTERY PACK

To remove: push and hold the battery pack release button upwards, then slide the battery pack free.

To attach: mate the notched ends of the transceiver and the battery pack, then click the battery into place.

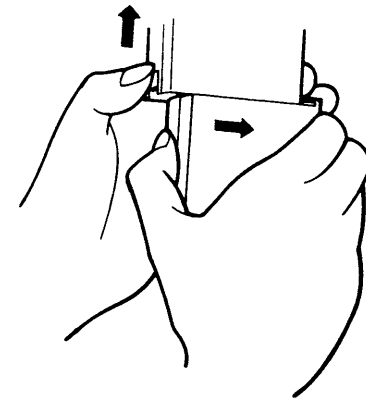

1 PRE-OPERATION

■ Charging notes

- **NEVER** attempt to charge non-rechargeable batteries with the BP-90.
- Connect a charger as illustrated in the following diagrams. **NEVER** connect two or more chargers at the same time.
- The transceiver must be turned OFF when charging a battery pack attached to the transceiver. Failure to do so may damage the transceiver.
- Charging may not be successful in extreme cold (under 0°C ; +32°F) or extreme heat (over +40°C ; +104°F).
- The use of non-Icom battery packs/chargers may impair transceiver performance and invalidate the warranty.

■ Battery life

If your battery pack seems to have no capacity even after being charged, completely discharge it by leaving the power ON overnight. Then, fully charge the battery pack again. If the battery pack still does not retain a charge (or very little), a new battery pack must be purchased.

■ Cautions

NEVER incinerate used battery packs. Internal battery gas may cause an explosion.

NEVER immerse the battery pack in water. If the battery pack becomes wet, be sure to wipe it dry.

NEVER short terminals of the battery pack. Internal components may become damaged. Also, current may flow into nearby metal objects so be careful when placing battery packs in handbags, etc.

• Using supplied wall charger

Connect the supplied wall charger to the [CHARGE] jack.

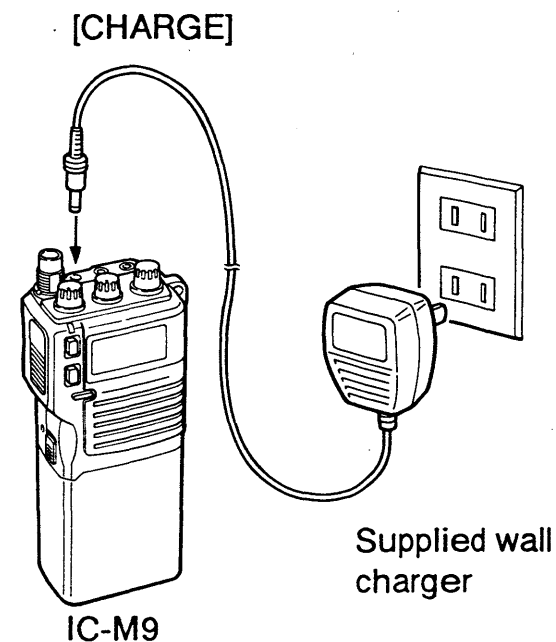

Charging time: 15 hrs. (approx.)

• **Using an optional BC-72**

Insert the battery pack into the charging slot of the BC-72.

The BP-90 BATTERY CASE cannot be charged using the BC-72 even when Ni-Cd batteries are installed.

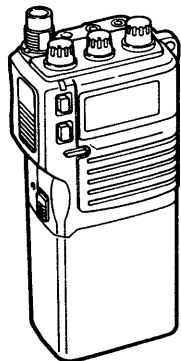

Connect the wall charger supplied with the BC-72.

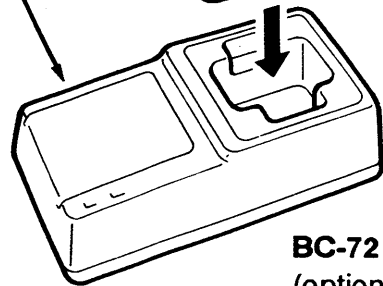

BC-72
(optional)

Charging time: 1 to 3 hrs. (approx.)

• **Optional charger and cables**

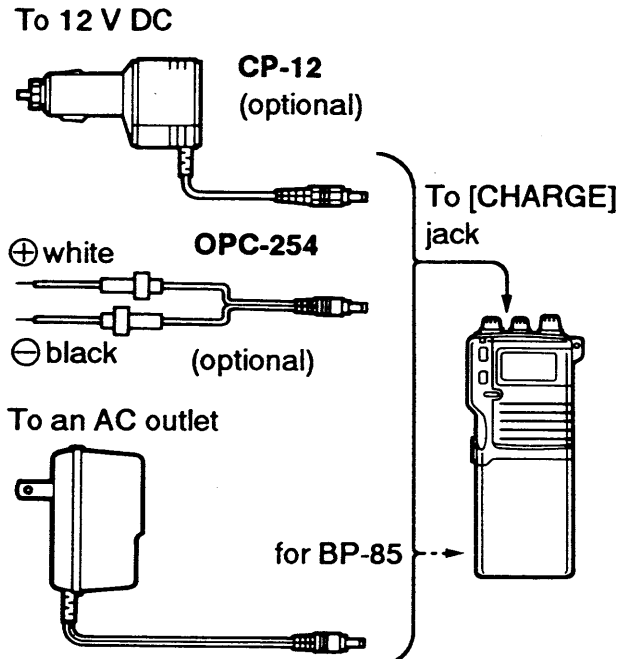

BC-74A/E/D/V or BM-76A/E/D/V
(BC-73E/D charges only BP-81 or BP-82.)

BC-73E/D: for BP-81 or BP-82
BC-74A/E/D/V: for BP-81 to BP-85
BM-76A/E/D/V: for CM-89

Charging time: 15 hrs. (approx.)

• **Charging without the transceiver**

To charge the battery pack separately from the transceiver, use the optional AD-14.

AD-14 (optional)

Connect a cable or charger as described at left.

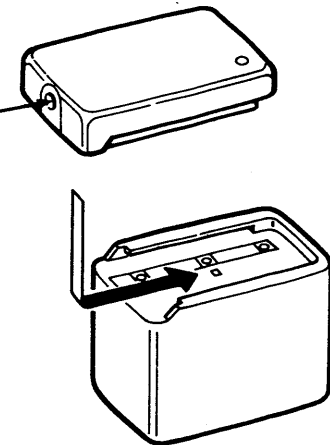

Since the BP-85 has an independent charging jack, it cannot be charged via the AD-14.

Charging time: 15 hrs. (approx.)

Front and side panels

TRANSMIT POWER SWITCH

[HI/LOW] (p. 10)

Selects high or low output power. Also activates the secondary function of other switches.

PTT SWITCH [PTT] (p. 10)

Push and hold to transmit; release to receive.

DUAL WATCH/SCAN SWITCH

[DW/SCAN] (pgs. 9, 14)

Starts and stops dual/tri-watch. When pushed and held, starts one of the scans.

In addition, when [HI/LOW] is pushed and held, this switch locks out the indicated channel.

BATTERY PACK RELEASE

BUTTON (p. 2)

Opens latch for battery pack removal when pushed upwards.

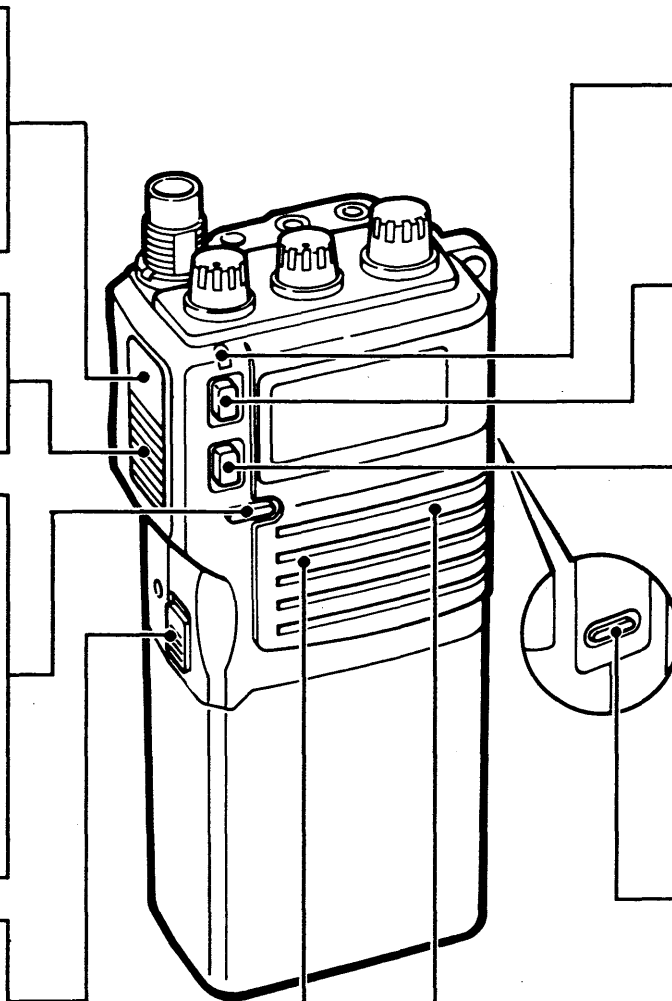

SPEAKER

MICROPHONE

TRANSMIT/RECEIVE INDICATOR

[TX] (pgs. 9, 10)

Lights up in green while the squelch is open; red while transmitting.

CHANNEL 16 SWITCH [16] (p. 8)

Toggles between channel 16 and a regular channel.

CALL/MEMORY SWITCH [C/M]

(p. 8)

Selects the call channel, a memory channel or a regular channel.

When [HI/LOW] is pushed and held, this switch enters call/memory channel programming mode.

LIGHT SWITCH

[LIGHT(SCRM)/LOCK] (pgs. 10, 16)

Turns the function display lighting ON and OFF.

When pushed and held, activates the optional scrambler unit.

In addition, when [HI/LOW] is pushed and held, activates the lock function.

■ Top panel

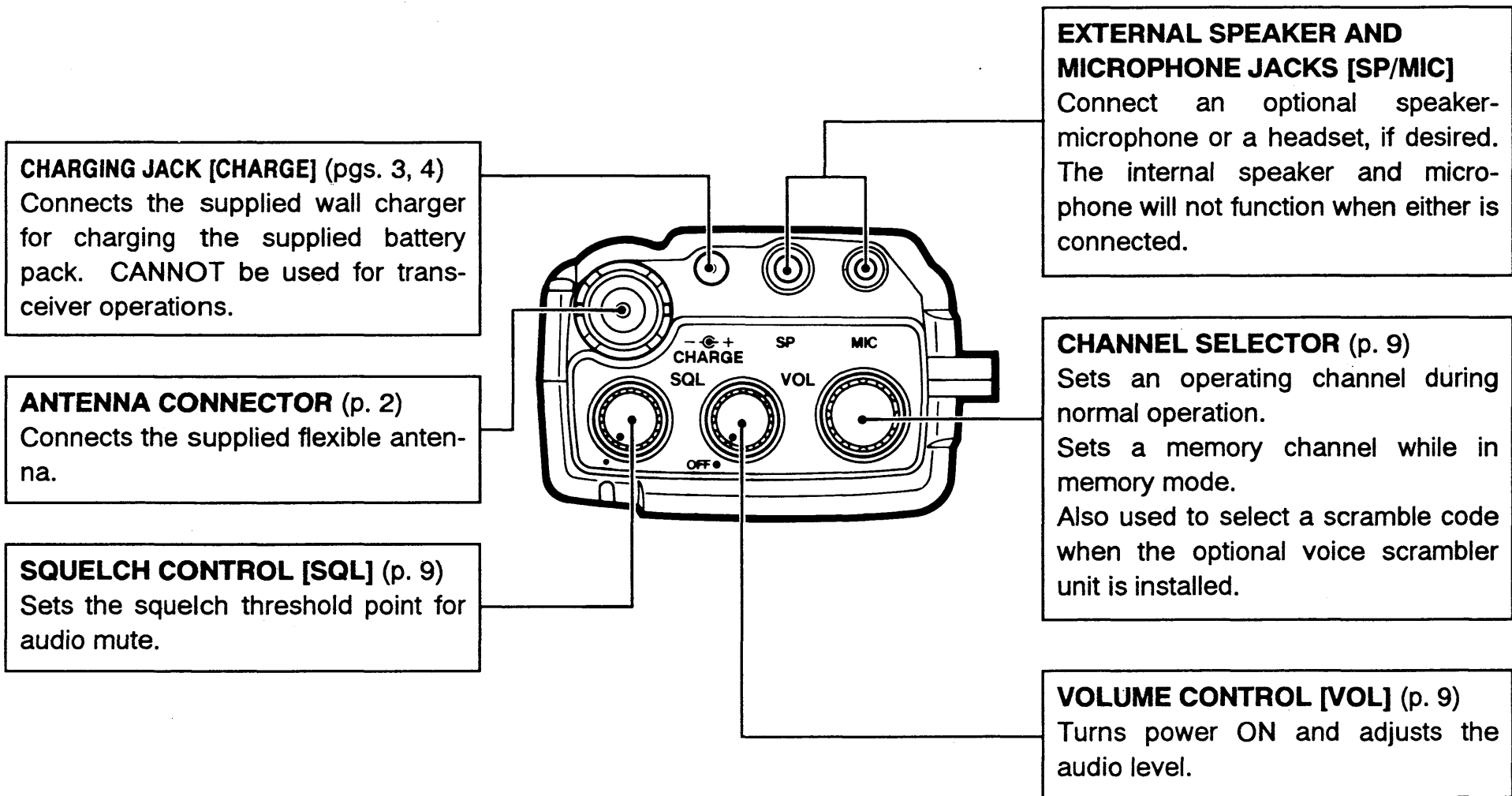

2 PANEL DESCRIPTION

■ Function display

INTERNATIONAL CHANNEL INDICATOR (p. 8)
Indicates that the displayed channel is an international channel.

SCAN INDICATOR (p. 14)
Appears while a scan is activated.

LOCK INDICATOR (p. 10)
Appears while the lock function is activated.

DUAL WATCH INDICATOR (p. 9)
"DUAL" appears during dual watch; "DUAL" and "▼" appear during tri-watch.

CALL CHANNEL INDICATOR (p. 8)
Indicates the call channel is selected.

TRANSMIT POWER INDICATOR (p. 10)
Appears when low output power is selected; disappears when high output power is selected.
High output power cannot be selected on some channels. (See channel list, p. 18.)

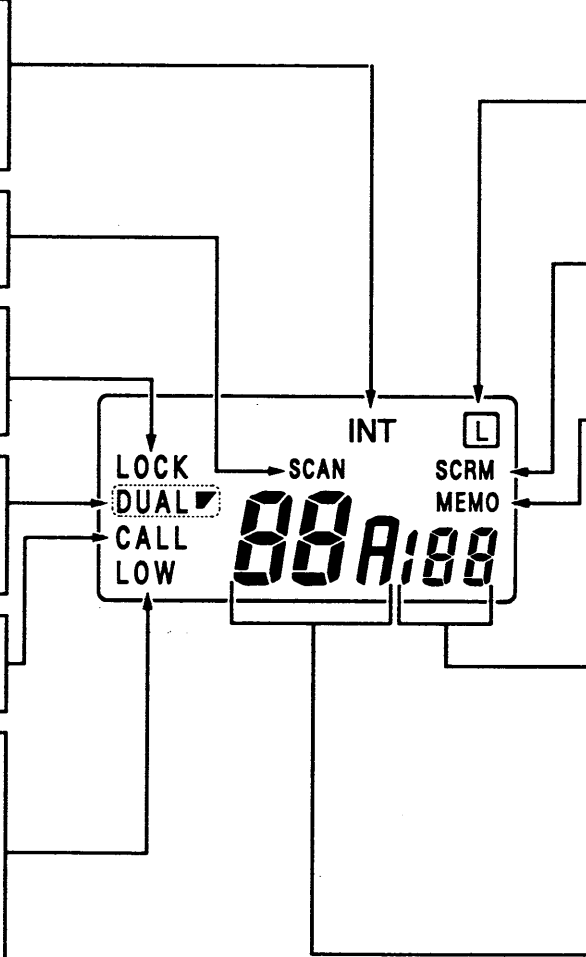

LOCKOUT CHANNEL INDICATOR (p. 14)
Indicates that the displayed channel is locked out.

SCRAMBLER INDICATOR (p. 16)
Indicates that the optional voice scrambler function is activated.

MEMORY INDICATOR (p. 8)
Indicates that the transceiver is in memory mode.

MEMORY CHANNEL/SCRAMBLE NUMBER CODE (pgs. 11, 16)
Indicates the selected memory channel number or the scrambler code number while setting a scramble code.
In SET mode, indicates the selected condition.

CHANNEL NUMBER INDICATOR (p. 8)
Indicates the selected operating channel number.
In SET mode, indicates the selected item.

■ Channel selection

◇ Channel 16

Channel 16 is the distress channel. It is used for establishing initial contact with another station and for emergency communications. While standingby you are required to monitor channel 16.

Push 

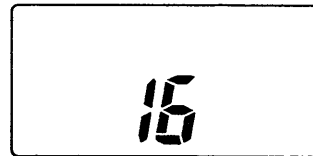

◇ Regular channels

There are 85 international channels available. Establish initial contact on channel 16, then move to an agreed upon channel for communications. Some channels can only transmit at low power (see the channel list, p. 18).

Push  twice

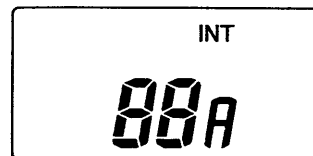

- When channel 16 is selected, push [16] once.
- Rotate the channel selector to set the desired channel.

◇ Call channel

The call channel is used to store your most often-used channel for quick recall. In addition, the call channel is monitored during tri-watch. The default for the call channel is channel 16.

Push 

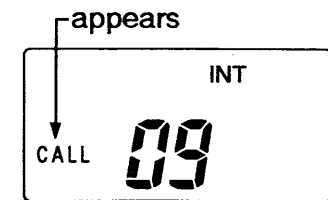

- When a memory channel is selected, push [C/M] twice.
- See page 11 for call channel programming.

◇ Memory channels

24 memory channels are used to store often-used frequencies for easy recall and scanning. After shipping from the factory or after resetting the CPU (p. 18) only memory channel 00 is programmed.

Push  twice

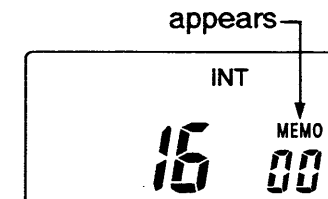

- When the call channel is selected, push [C/M] once.
- Rotate the channel selector to set the desired memory channel.
- See p. 11 for memory channel programming.

3 BASIC OPERATION

■ Receiving

- 1) Rotate [VOL] clockwise to turn power ON.
- 2) Rotate [SQL] fully counterclockwise.
- 3) Adjust the audio to a suitable level using [VOL].
- 4) Rotate [SQL] clockwise until audio noise is just muted.
- 5) Rotate the channel selector to set the desired channel for receiving.
 - See the previous page for how to select channel 16, regular channels, the call channel or memory channels.

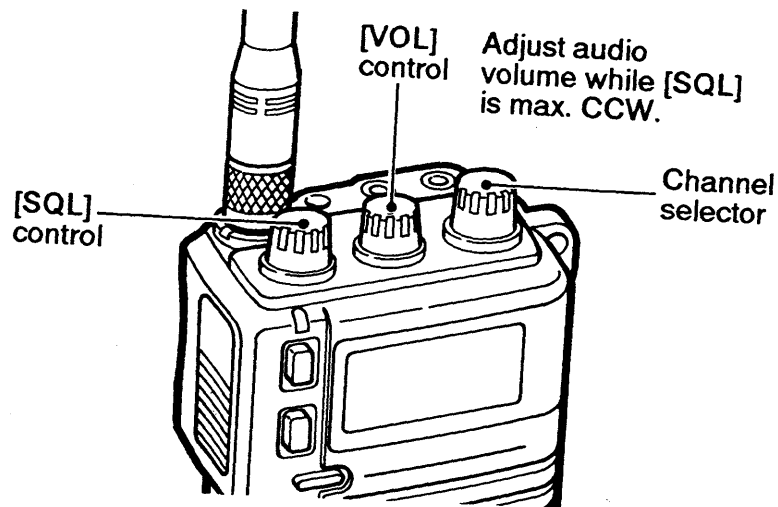

■ Dual watch/tri-watch

This function monitors Channel 16 (and the Call channel in the case of tri-watch) while waiting on a selected channel. Set the transceiver for tri- or dual watch in SET mode depending on your preference. (See p. 12.)

- 1) Set your desired receive channel. See p. 8.
 - If the Call channel is selected, only dual watch is possible.

- 2) Push [DW/(SCAN)] to activate the watch.

- When a signal is received on Ch 16 the watch pauses and "16" flashes until the signal disappears.
- When a signal pauses on the Call channel, Ch 16 is still monitored.

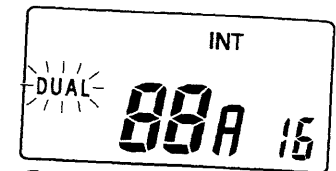

Dual watch

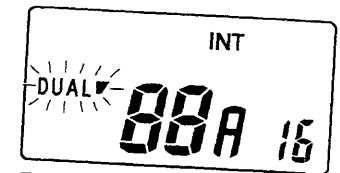

Tri-watch

- 3) Push [DW/(SCAN)] to cancel the watch.

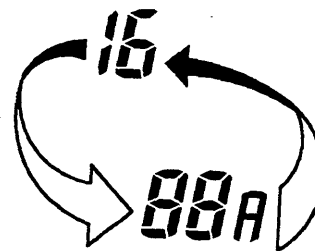

Dual watch

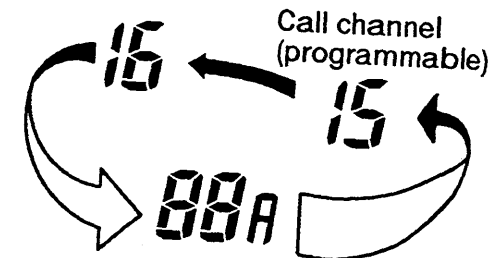

Tri-watch

■ Transmitting

CAUTION: Transmitting without an antenna may damage the transceiver.

Set the transceiver as for receiving, then:

- 1) Set the desired channel using the channel selector.
- 2) Push [HI/LOW] to select the output power.
 - “LOW” appears when low power is selected.
 - Choose low power to conserve battery power; choose high power for longer distance communications.
- 3) Push and hold [PTT] to transmit.
 - [TX] lights up in red.
 - Some channels are for low power output only. (See channel list, p. 18).
 - To ensure privacy, use the voice scrambler function when transmitting. An optional UT-79 must be installed.
- 4) Speak into the microphone.
 - DO NOT hold the transceiver too closely to your mouth or speak too loudly. This may distort the signal.
- 5) Release [PTT] to receive.

■ Lock function

This function electronically locks all keys and switches to prevent accidental frequency changes and function access.

- 1) While pushing [HI/LOW], push [LIGHT/LOCK].
 - Only [PTT], [HI/LOW] and [LIGHT] are functional.
 - Push [16] to cancel the lock function and select channel 16.

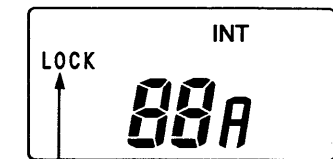

appears

- 2) To cancel the function, repeat step 1 above.
 - “LOCK” disappears from the function display.

■ Function display backlighting

This is convenient for nighttime operation.

- 1) Push [LIGHT/LOCK] to turn the function display backlighting ON.
 - The backlighting automatically turns OFF after 5 sec. if no other keys or switches are pushed during that time.
 - To conserve battery power, use the backlighting only when necessary.
- 2) To turn the function display backlighting OFF before 5 sec. have elapsed, push [LIGHT/LOCK] again.

Memory channels

◇ To program:

1) Push [C/M] once or twice to select a memory channel.

2) While pushing [HI/LOW], push [C/M].

- "MEMO" and the memory channel number flash.

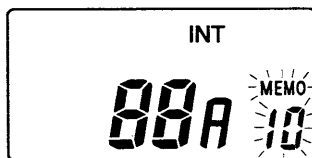

3) Rotate the channel selector until the desired memory appears.

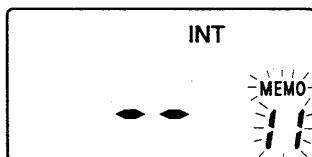

4) Push [C/M] again.

- The channel indication flashes.

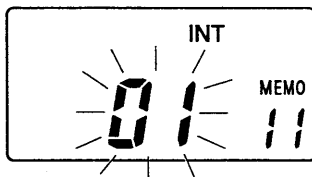

5) Rotate the channel selector until the desired channel appears.

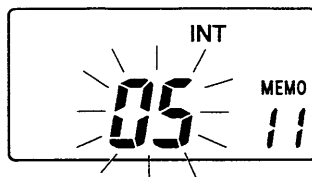

6) While pushing [HI/LOW], push [C/M] to complete programming.

- The channel number stops flashing.

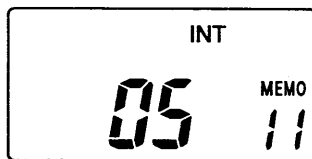

Call channel

◇ To program:

1) Push [C/M] once or twice to select the call channel.

2) While pushing [HI/LOW], push [C/M].

- The call channel flashes.

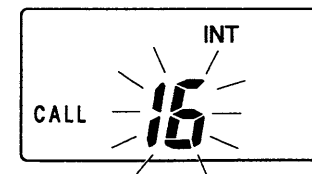

3) Rotate the channel selector until the desired channel appears.

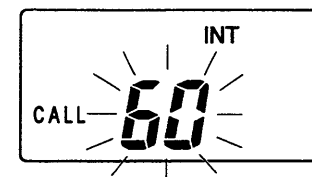

4) While pushing [HI/LOW], push [C/M] again to complete programming.

- The channel number stops flashing.

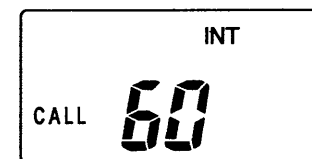

■ SET mode programming

SET mode is used to change the conditions of 3 transceiver functions: the power saver function, the dual/tri-watch function and the scan function.

- 1) Turn power OFF.
- 2) While pushing [HI/LOW], turn power ON and continue pushing [HI/LOW] until the display appears.
- 3) After the display appears, release [HI/LOW].
- 4) Push [HI/LOW] to select the desired item, if necessary.
- 5) Rotate the channel selector to select the desired condition of the item as shown in the table at right.
- 6) To exit SET mode, push [16].
 - Turning power OFF, then ON again also exits SET mode.

These displays show the default settings.

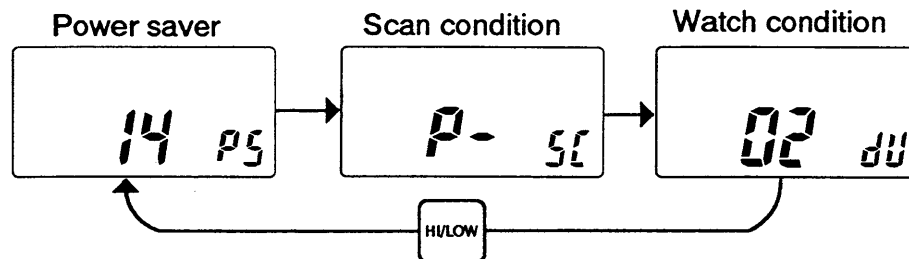

■ SET mode items

DISPLAY	CONDITION	COMMENT
00 PS	Power saver OFF	The power saver function helps conserve battery power by automatically resting the receiver circuit when the transceiver is idle. For maximum battery conservation, choose the highest duty cycle: 1 : 8
14 PS	Power saver duty cycle 1 : 4	
18 PS	Power saver duty cycle 1 : 8	
P- SC	Priority scan	Select priority scan if you want to monitor the distress channel (16) while scanning.
L- SC	Normal scan	
02 DU	Dual watch operation	Choose tri-watch if you want to monitor the call channel in addition to channel 16 and a selected channel.
03 DU	Tri-watch operation	

Scan types

Scanning is an efficient way to locate signals quickly over a wide frequency range. The IC-M9 has 4 scan types:

Priority scan searches through all channels in sequence while monitoring channel 16. When a signal is detected on channel 16, scan pauses until the signal disappears; when a signal is detected on a channel other than channel 16, scan becomes dual watch until the signal disappears. A small 16 appears in the display indicating priority scan, and flashes when a signal is received on channel 16.

Normal scan, like priority scan, searches through all channels in sequence (either regular or memory channels). However, unlike priority scan, channel 16 is only checked in sequence as other channels are.

NOTE: Choose either priority or normal scan in SET mode (see p. 12).

- Priority regular scan
- Normal regular scan
- Priority memory scan
- Normal memory scan

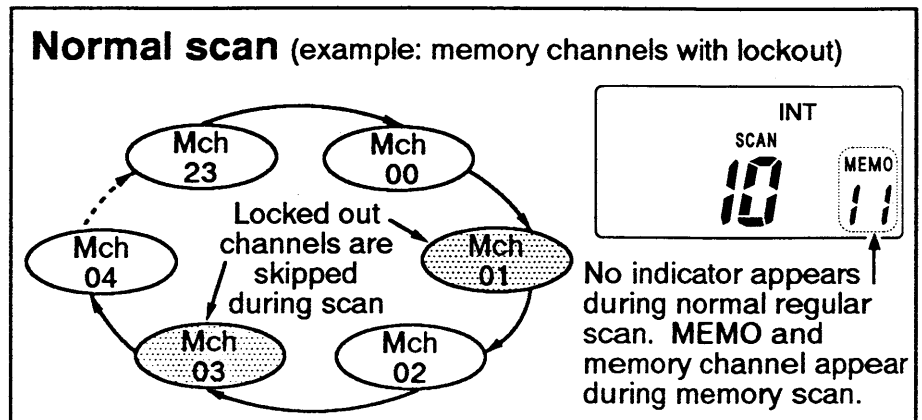
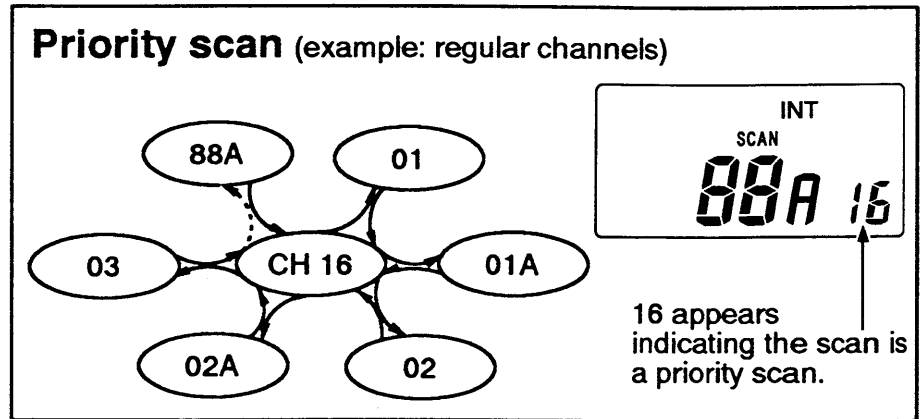

Starting a scan

Set priority scan or normal scan in advance using SET mode (see pgs. 12).

- 1) Make sure channel 16 or the call channel is not selected.
 - Select a regular channel or memory channel (see p. 8).
- 2) Push and hold [DW/(SCAN)] for 2 seconds.
 - "SCAN" appears in the function display.
 - When a priority scan is selected "16" appears instead of the memory channel.
 - When a signal is detected, scan pauses until the signal disappears. (Ch 16 is still monitored during priority scan.)
- 3) To stop the scan, push [DW(SCAN)].
 - "SCAN" disappears.
 - Pushing [16] or [C/M] also stops the scan.

Channel lockout

For more efficient scanning, set unwanted channels as lockout channels. Channels set as lockout channels will be skipped during scanning. Channel lockout is assigned to regular channels and memory channels independently.

- 1) Select the channel to be locked out (either a regular channel or a memory channel).
 - Channel 16 or the call channel cannot be locked out.
- 2) While pushing [HI/LOW], push [DW(SCAN)].
 - "☐" appears in the function display and the channel is locked out.
- 3) To unlock a channel, repeat step 2) above.

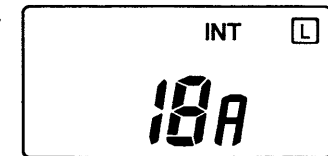

This example shows a regular channel locked out.

Starting a scan (example — normal scan of regular channels):

Push [16] or [C/M] once or twice if channel 16, the call channel or memory mode is selected.

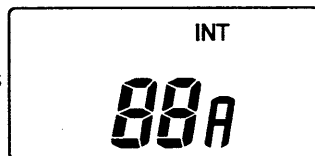
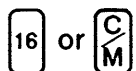

Push for 2 secs. Scan starts

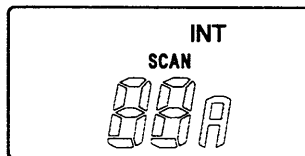

Scan pauses when receiving a signal and audio is emitted.

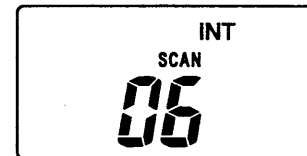

Push to stop the scan.



Installation

Before attempting the installation, turn the power OFF and remove both the battery pack and antenna.

- 1) Use a small Phillips screwdriver to remove the four rear panel screws and front panel screw as illustrated on the right.
- 2) Grasp the transceiver with both hands and gently separate the front and rear panels, opening from the PTT side.
 - The panels cannot be completely separated because of circuit connections.
- 3) Remove the unit marked (A) and replace with the UT-79 as illustrated on the right.
- 4) Reassemble the transceiver.
 - After reassembly, test the scrambler function. (See following page.) If there is a problem, check to see if the UT-79 has been installed correctly.

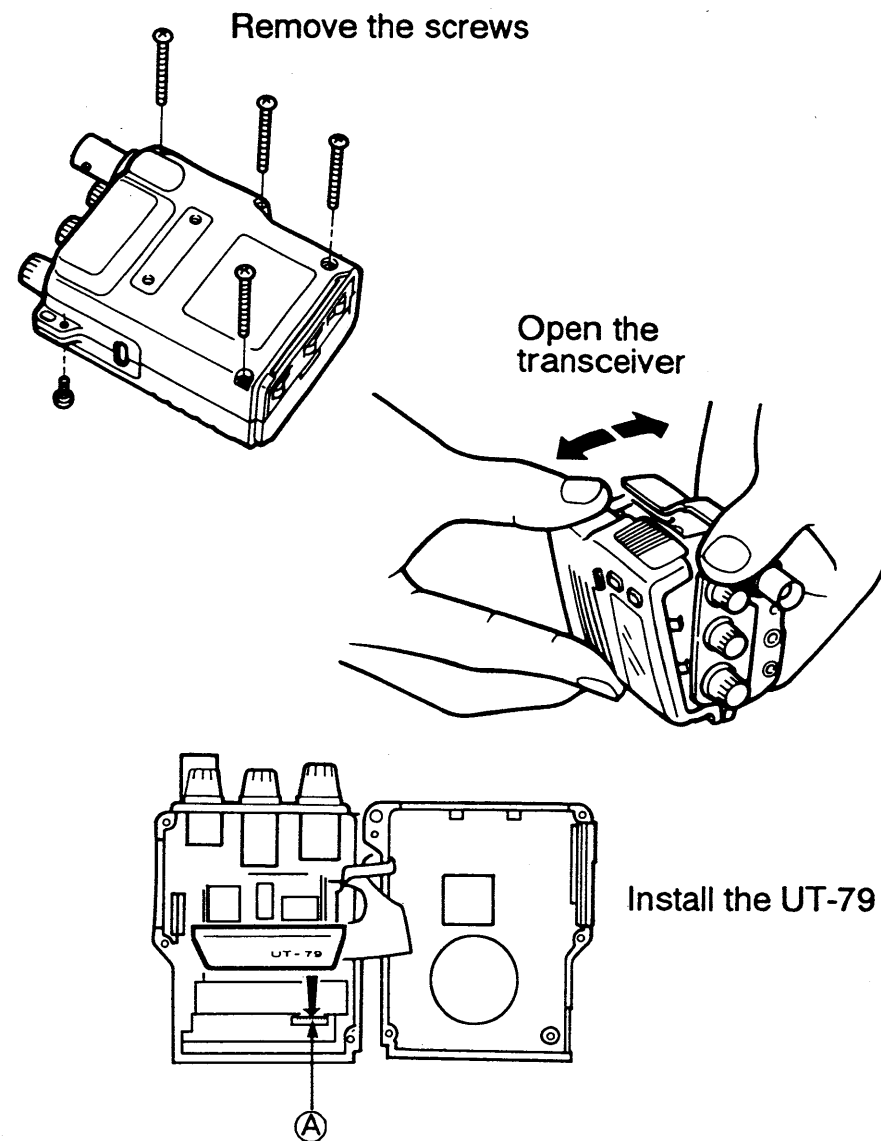

■ Activating the scrambler

The optional voice scrambler provides private communications. In order to receive or send scrambled transmissions you must first activate the scrambler function. To activate the function:

- 1) Push and hold [LIGHT(SCRM)/LOCK] for 2 seconds.
 - The transceiver emits 2 beeps and "SCRM" appears in the function display.
- 2) To turn the scrambler function OFF, repeat step 1).
 - The transceiver emits 2 beeps and "SCRM" disappears from the function display.

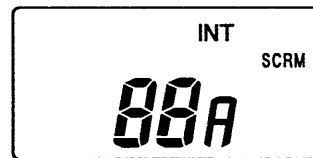

NOTE: The voice scrambler function CANNOT be activated on Channel 16.

■ Programming codes

There are 128 codes available for programming. In order to understand one another, all transceivers in your group must have the same code programmed into the channel you are communicating on.

- 1) Select the channel you wish to program a code into.
 - Channel 16 cannot be selected.
- 2) Make sure the scramble function is OFF, then push and hold [LIGHT(SCRM)/LOCK] until "SCRM" appears.
- 3) While continuing to push [LIGHT(SCRM)/LOCK], rotate the channel selector to select the desired scramble code.
- 4) Release [LIGHT(SCRM)/LOCK].
 - The scramble code disappears from the function display but remains in effect while the scramble function is activated.

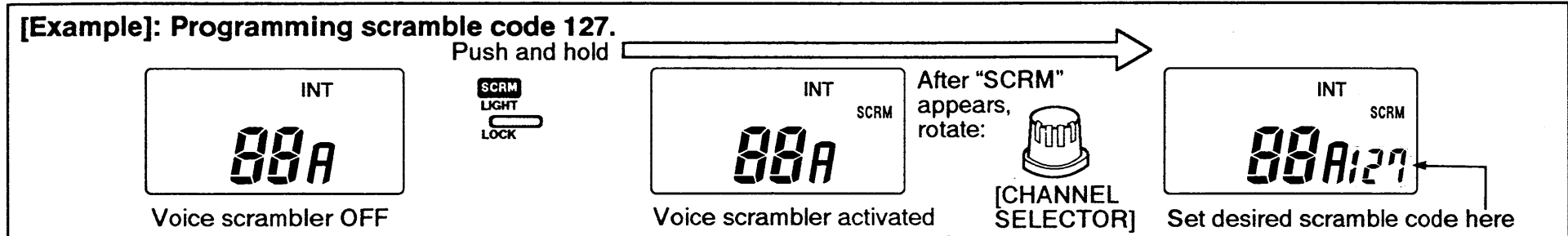

■ Troubleshooting

PROBLEM	POSSIBLE CAUSE	SOLUTION	REF.
No power comes ON.	<ul style="list-style-type: none"> • The battery is exhausted. • Bad connection to the battery pack. 	<ul style="list-style-type: none"> • Recharge the battery pack. • Check the battery pack connection to the transceiver. 	p. 3-4 —
No sound comes from the speaker.	<ul style="list-style-type: none"> • [SQL] is turned too far CW. • External speaker or earphone is in use. • [VOL] is turned completely CCW. 	<ul style="list-style-type: none"> • Set [SQL] to the threshold point. • Disconnect the external speaker or earphone. • Set [VOL] to a suitable level. 	p. 9 p. 6 p. 9
Transmitting is impossible, or high power cannot be selected.	<ul style="list-style-type: none"> • Channels 15 and 17 are for low power only. • The battery is exhausted. • The output power is set to low. 	<ul style="list-style-type: none"> • Change channels. • Replace or charge the batteries. • Push [HI/LOW] to select high output power. 	p. 10 p. 3-4 p. 10
The displayed channel cannot be changed.	<ul style="list-style-type: none"> • Lock function is activated. • Channel 16 mode has been selected. • Dual/tri-watch has been activated. • Scan has been activated. 	<ul style="list-style-type: none"> • While pushing [HI/LOW], push [LIGHT/LOCK]. • Push [16] to return to normal operation. • Push [DW(SCAN)] to cancel dual/tri-watch. • Push and hold [DW(SCAN)] to cancel scanning. 	p. 10 p. 8 p. 9 p. 14
Scanning or dual watch/tri-watch does not function.	<ul style="list-style-type: none"> • Channel 16 mode has been selected. • The squelch is open. 	<ul style="list-style-type: none"> • Push [16] to return to normal operation. • Rotate [SQUELCH] clockwise. 	p. 8 p. 14
Memory scan does not function	<ul style="list-style-type: none"> • 2 or more memory channels must be programmed with channel information 	<ul style="list-style-type: none"> • Program 2 or more memory channels with channel information 	p. 11
Dual watch functions but tri-watch doesn't or vice versa.	<ul style="list-style-type: none"> • You must set the transceiver to operate one or the other. 	<ul style="list-style-type: none"> • Select dual watch or tri-watch operation in SET mode. 	p. 12
Receive signal cannot be understood.	<ul style="list-style-type: none"> • Optional voice scrambler has been turned OFF. • Voice scrambling code has not been set correctly (when the scrambler has been turned ON.) 	<ul style="list-style-type: none"> • Turn the optional voice scrambler ON. • Reset the scrambling code. 	p. 16 p. 16

Resetting the CPU

CAUTION: Resetting the CPU erases all memory contents and user-programmed SET mode conditions and returns the transceiver to its default settings.

- ① While pushing [HI/LOW] and [DW/SCAN], turn the transceiver's power ON.
- All segments of the LCD appear.

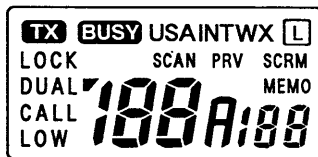

- ② Continue pushing [HI/LOW] and [DW/SCAN] until the only indication in the display is the ch16 indication.
- All memory channel contents are erased and all user-programmed SET mode conditions are returned to their default settings.

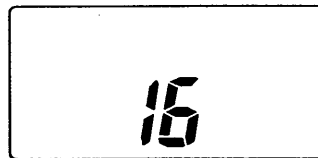

Channel list

CH	Frequency (MHz)		CH	Frequency (MHz)		CH	Frequency (MHz)	
	TX	RX		TX	RX		TX	RX
01	158.050	180.650	21	157.050	181.650	71	158.575	158.575
01A	158.050	158.050	21A	157.050	157.050	72	158.625	158.625
02	158.100	180.700	22	157.100	181.700	73	158.675	158.675
02A	158.100	158.100	22A	157.100	157.100	74	158.725	158.725
03	158.150	180.750	23	157.150	181.750	77	158.875	158.875
03A	158.150	158.150	23A	157.150	157.150	78	158.925	181.525
04	158.200	180.800	24	157.200	181.800	78A	158.925	158.925
04A	158.200	158.200	25	157.250	181.850	79	158.975	181.575
05	158.250	180.850	26	157.300	181.900	79A	158.975	158.975
05A	158.250	158.250	27	157.350	181.950	80	157.025	181.625
06	158.300	158.300	28	157.400	182.000	80A	157.025	157.025
07	158.350	180.950	60	158.025	180.625	81	157.075	181.675
07A	158.350	158.350	60A	158.025	158.025	81A	157.075	157.075
08	158.400	158.400	61	158.075	180.675	82	157.125	181.725
09	158.450	158.450	61A	158.075	158.075	82A	157.125	157.125
10	158.500	158.500	62	158.125	180.725	83	157.175	181.775
11	158.550	158.550	62A	158.125	158.125	83A	157.175	157.175
12	158.600	158.600	63	158.175	180.775	84	157.225	181.825
13	158.650	158.650	63A	158.175	158.175	84A	157.225	157.225
14	158.700	158.700	64	158.225	180.825	85	157.275	181.875
15*	158.750	158.750	64A	158.225	158.225	85A	157.275	157.275
16	158.800	158.800	65	158.275	180.875	86	157.325	181.925
17*	158.850	158.850	65A	158.275	158.275	86A	157.325	157.325
18	158.900	181.500	66	158.325	180.925	87	157.375	181.975
18A	158.900	158.900	66A	158.325	158.325	87A	157.375	157.375
19	158.950	181.550	67	158.375	158.375	88	157.425	182.025
19A	158.950	158.950	68	158.425	158.425	88A	157.425	157.425
20	157.000	181.600	69	158.475	158.475			
20A	157.000	157.000	70*	158.525	158.525			

*Low power only

Specifications

• GENERAL

Frequency coverage	: Transmit 156–157.5 MHz Receive 156–163 MHz
Mode	: FM (16K0G3E)
Channel spacing	: 25 kHz
Current drain (at 12.5 V)	: TX High 1.8 A max. TX Low 0.9 A max. Max. audio 300 mA max. Squelched 15 mA typical
Power supply requirement	: BP-81 to BP-85, BP-90 or CM-89
Usable temperature range	: -20°C to +60°C (-4°F to +140°F)
Dimensions (with CM-89)	: 49(W) × 123(H) × 33(D) mm 1.9(W) × 4.8(H) × 1.3(D) in
Weight (with CM-89)	: 310 g; 10.9 oz
Antenna impedance	: 50 Ω (unbalanced)

• TRANSMITTER

Output power*	: High 5 W Low 0.5 W *Varies with battery pack used
Modulation system	: Variable reactance phase modulation
Max. frequency deviation	: ± 5.0 kHz

• RECEIVER

Receive system	: Double-conversion superheterodyne
Sensitivity (12 dB SINAD)	: 0.35 μV
Squelch sensitivity	: Less than 0.3 μV (at threshold)
Audio output power	: 500 mW with an 8 Ω load

All stated specifications are subject to change without notice or obligation.

Options

Icom offers a wide variety of options to suit your operating needs.

◇ MICROPHONES AND HEADSET

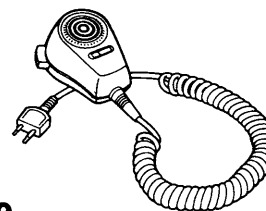

CM-9
SPEAKER-MICROPHONE
Combination speaker and microphone.

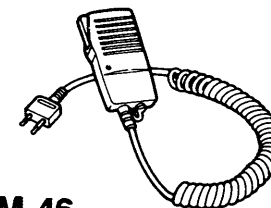

HM-46
SPEAKER-MICROPHONE
Combination speaker and microphone equipped with an earphone jack.

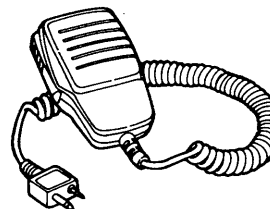

HM-54
SPEAKER-MICROPHONE
Combination speaker and microphone.

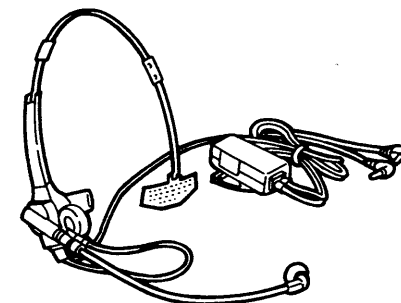

HS-51 HEADSET
Lightweight headset with VOX function.

◇ CHARGERS

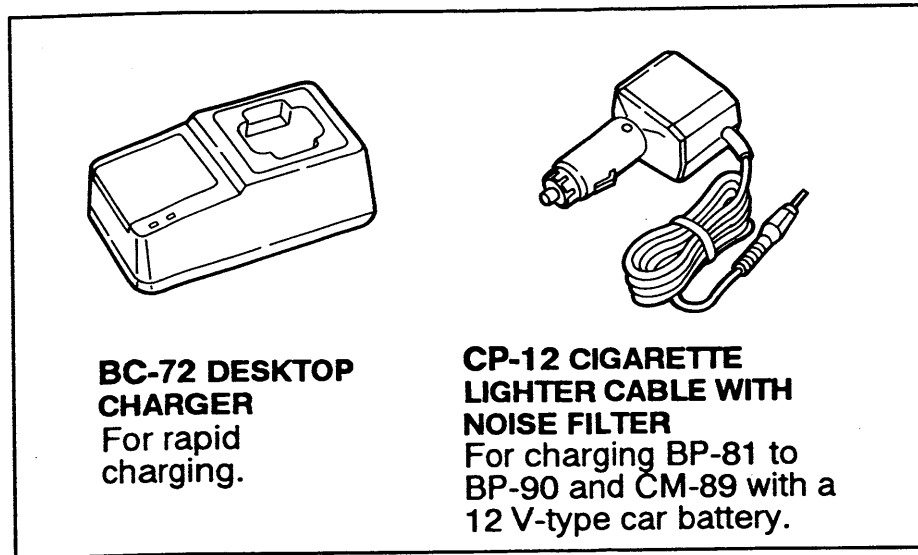

BC-72 DESKTOP CHARGER
For rapid charging.

CP-12 CIGARETTE LIGHTER CABLE WITH NOISE FILTER
For charging BP-81 to BP-90 and CM-89 with a 12 V-type car battery.

- **AD-14 BATTERY CHARGE ADAPTER**
Used for charging battery packs (BP-81 to BP-84, BP-90) separated from the IC-M9.
- **BC-73E/D WALL CHARGER**
For charging BP-81 or BP-82.
- **BC-74A/E/D/V WALL CHARGER**
For charging BP-81 to BP-90.
- **BC-76A/E/D/V WALL CHARGER**
For charging CM-89.
- **OPC-254 MINI DC POWER CABLE**
For charging BP-81 to BP-90 and CM-89 via 12 V DC power.

◇ BATTERIES AND CASE

BATTERY	OUTPUT VOLTAGE	BATTERY CAPACITY	HEIGHT (mm/in)	CARRYING CASES
BP-81	7.2 V	110 mAh	30.0/1.2	LC-53
BP-82	7.2 V	400 mAh	40.0/1.6	LC-55
BP-83	7.2 V	600 mAh	59.5/2.3	LC-55
BP-84	7.2 V	1000 mAh	76.0/3.0	LC-56
BP-85	12.0 V	400 mAh	76.0/3.0	LC-56
BP-90	Battery case for 6 R6 (AA) batteries		59.5/2.3	LC-55
CM-89	9.6 V	400 mAh	59.5/2.3	LC-55

◇ OTHERS

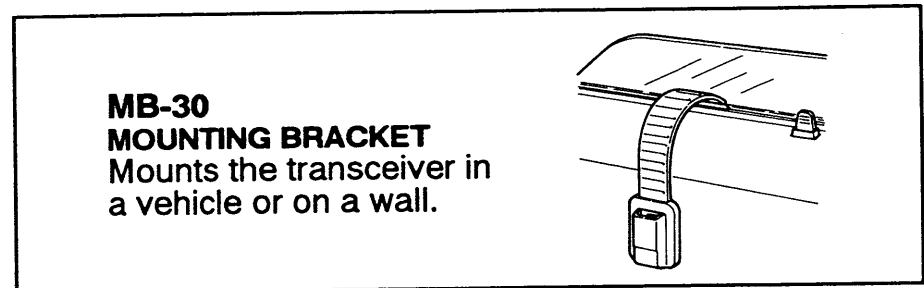

MB-30 MOUNTING BRACKET
Mounts the transceiver in a vehicle or on a wall.

- **FA-150T FLEXIBLE ANTENNA**
Same type as supplied with the transceiver.
- **FA-150TA FLEXIBLE ANTENNA**
Short-type antenna.
- **UT-79 VOICE SCRAMBLER UNIT**
Ensures private communications. 128 codes available.

Count on us!

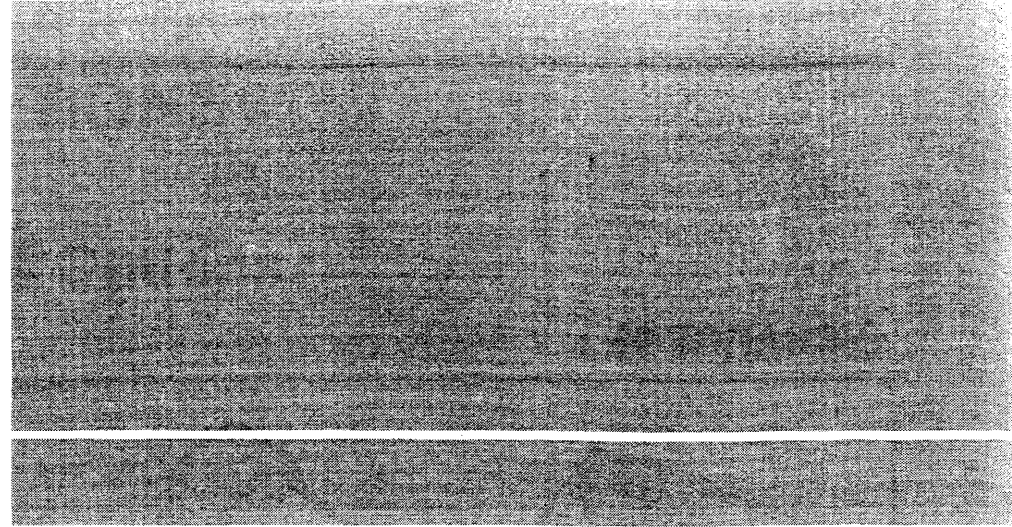

A-5262S-1EX
Printed in Japan
Copyright © 1993 by Icom Inc.



Icom Inc.
6-9-16, Kamihigashi, Hirano-ku, Osaka 547, Japan